

# MS Series Mortise Locks

## Commercial Lockset



ANSI/BHMA CERTIFIED GRADE 1 MORTISE LOCKSET  
UL & ULC LISTED 3-HOUR FIRE RATING  
AVAILABLE IN REGULAR AND CLUTCHED FUNCTIONS



Regular (R) Rose  
W/ Sentinel (S) Lever

### MSS-R

- Available Levers/Knob: Sentinel (S), Gala (G), Imperial (I), Quest (Q), Artistic (A), Congress (C), Tango (T), Regal (R)
- Available Finishes: US3, US4, US26, US26D, US32, US32D, US10B, US15
- Sectional Rose Style: Regular (R)



### MSE-R

- Available Levers/Knob: Sentinel (S), Gala (G), Imperial (I), Quest (Q), Artistic (A), Congress (C), Tango (T), Regal (R)
- Available Finishes: US3, US4, US26, US26D, US32, US32D, US10B, US15
- Escutcheon Style: Regular (R)

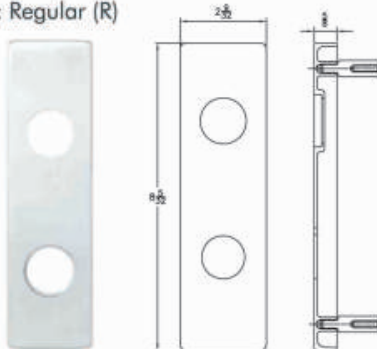

Regular (R) Escutcheon  
W/ Tango (T) Lever

ANSI/BHMA CERTIFIED GRADE 1 MORTISE LOCKSET  
 UL & ULC LISTED 3-HOUR FIRE RATING  
 AVAILABLE IN REGULAR AND CLUTCHED FUNCTIONS



**MS COMMERCIAL LOCKS**



Low (L) Rose  
 W/Sentinel (S) Lever

**MSS-L**

- Available Levers/Knob: Sentinel (S), Gala (G), Imperial (I), Quest (Q), Artistic (A), Congress (C), Tango (T), Regal (R)
- Available Finishes: US3, US4, US26, US26D, US32, US32D, US10B, US15
- Sectional Rose Style: Low (L)



**MSE-L**

- Available Levers/Knob: Sentinel (S), Gala (G), Imperial (I), Quest (Q), Artistic (A), Congress (C), Tango (T), Regal (R)
- Available Finishes: US3, US4, US26, US26D, US32, US32D, US10B, US15
- Escutcheon Style: Low (L)

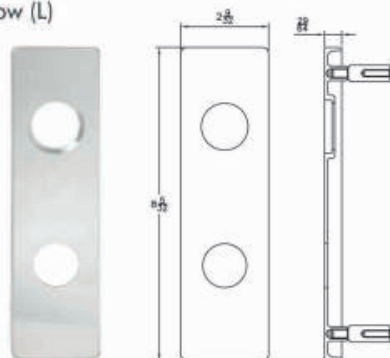

Low (L) Escutcheon  
 W/Sentinel (S) Lever

ANSI/BHMA CERTIFIED GRADE 1 MORTISE LOCKSET  
UL & ULC LISTED 3-HOUR FIRE RATING  
AVAILABLE IN REGULAR AND CLUTCHED FUNCTIONS



Wide (W) Escutcheon  
W/ Imperial (I) Lever

### MSE-W

- Available Levers/Knob: Sentinel (S), Gala (G), Imperial (I), Quest (Q), Artistic (A), Congress (C), Tango (T), Regal (R)
- Available Finishes: US3, US4, US26, US26D, US32, US32D, US10B, US15
- Escutcheon Style: Wide (W)

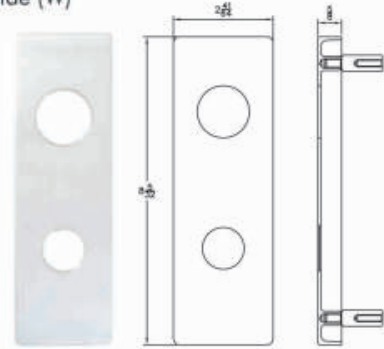

### Standard Thumb Turn



Classic Visible

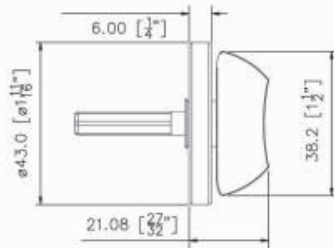

### Optional Thumb Turn



Classic Concealed

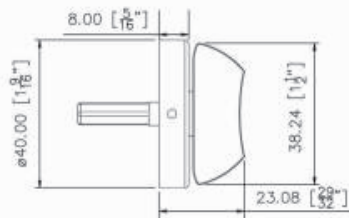

ADA

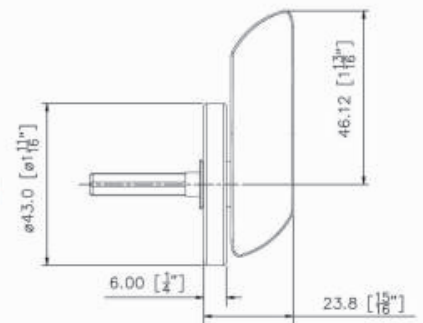

ANSI/BHMA CERTIFIED GRADE 1 MORTISE LOCKSET  
 UL & ULC LISTED 3-HOUR FIRE RATING  
 AVAILABLE IN REGULAR AND CLUTCHED FUNCTIONS



MS COMMERCIAL LOCKS

## Plated & Stainless Steel Knobs and Levers



Artistic

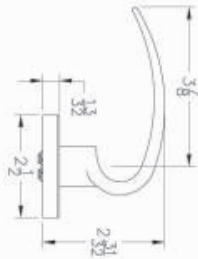

Congress

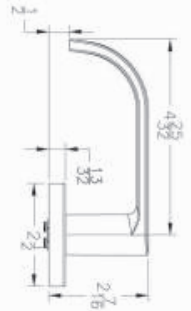

Gala

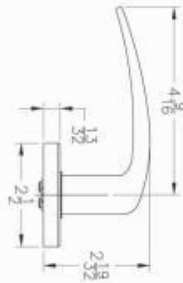

Imperial

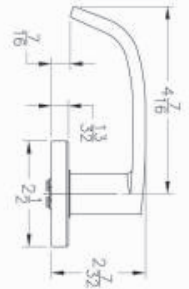

Quest



Regal

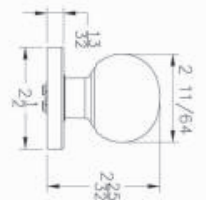

Sentinel

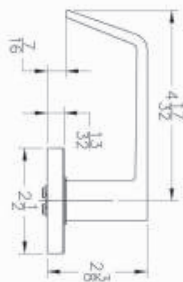

Tango

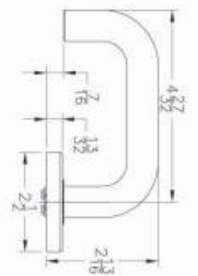

## MS Series Mortise Lock Profile

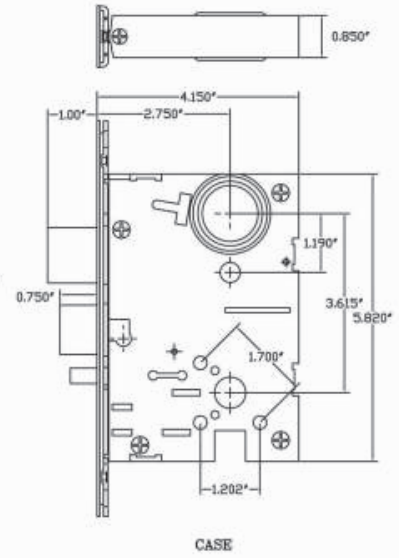
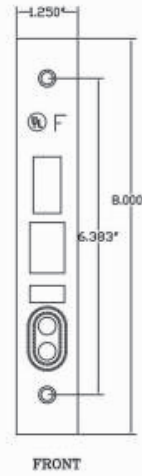
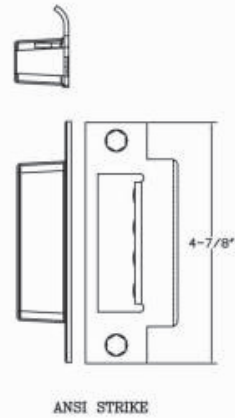

## Handing

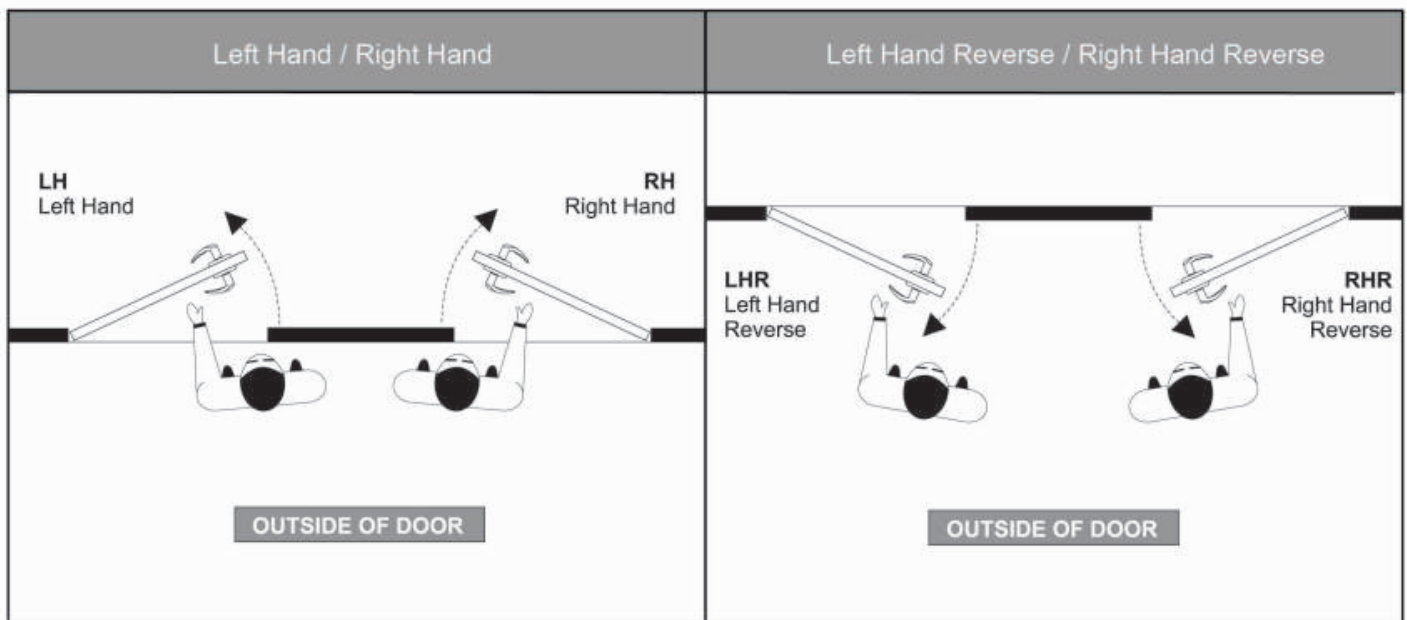

ANSI/BHMA CERTIFIED GRADE 1 MORTISE LOCKSET  
 UL & ULC LISTED 3-HOUR FIRE RATING  
 AVAILABLE IN REGULAR AND CLUTCHED FUNCTIONS

**MS COMMERCIAL LOCKS**

**Features**

- ANSI Grade 1 Heavy-Duty Mortise Lock
- Door Thickness: 1 3/4" Standard, Other Door Thickness available upon request.
- Backset 2 3/4"
- Armored Front Plate
- Stainless Steel Deadbolt with 1" Throw Anti-Saw Deadbolts with Hardened Pins
- Stainless Steel Latchbolt
- Tamper Proof Cylinder Collar
- Rocker Type Stop Works, Stainless Steel
- Handing is Field Reversible
- Available In 8 BHMA Finishes
- Keyway-Schlage C (standard), other upon request
- Brass Mortise Cylinder, 2 keys Per Cylinder
- Small Format Interchangeable Core Available, 6 or 7pin core
- High Security Mortise Cylinder Available
- High Security SFIC Core Available
- Master Keying, Grand Master Keying or Great Grand Master Keying Available
- UL Listed 3-Hour Fire Rating
- 10-year Manufacturer's Limited Warranty

**Specifications**

Mortise Lock- Sectional or Escutcheon models and series. ANSI Grade 1

**Standard Finishes**

US3(605)	US4(606)	US10B(613)	US15(619)	US26(625)	US26D(626)	US32(629)	US32D(630)
Bright Brass	Satin Brass	Oil Rubbed Bronze	Satin Nickel	Bright Chrome	Satin Chrome	Bright SST	Satin SST

Note: For other finishes, please consult factory

**Code Compliance**

- ANSI A-156.13-2005 Certified
- ADA Barrier Free Accessibility on All Lever Designs
- UL Listed 3-Hour Fire Rating



**Options**

- Strike- Brass or Stainless Steel, 1 1/4" x 4 7/8". Lipped ANSI strike
- Many other lever designs available, consult TownSteel for more information
- Clutching Mortise

**Clutching Features**

- Mortise Lock with Clutching mechanism
- Levers rotate up and down freely in the locked or unlocked positions
- Certified ANSI/BHMA A156.13 GRADE 1
- UL listed 3-hour fire rating
- Handing field reversible
- Patented Design
- TSM Series is MS mortise case with clutching mechanism assembled in Korea







**How To Order**

1.Trim Series	MSS-R (Sectional Regular) MSS-L (Sectional Low) MSE-R (Escutcheon Regular) MSE-L (Escutcheon Low) MSE-W (Escutcheon Wide)	<b>Order # Example:</b>  <b><u>MSS-R-04-Gala-626-RH-IC</u></b>  1. Sectional Regular _____ MSS-R 2. Office Function _____ 04 3. Gala Lever _____ Gala 4. Satin Chrome _____ 626 5. Right Handed _____ RH 6. Clutching (Optional) _____ C 7. Interchangeable Core(Optional) _____ IC
2.Function	See Mortise Function Sheet	
3.Lever	See Lever Listing	
4.Finish	See Finish Listing	
5.Handing	RH      LH      RHR      LHR	

# MS Series Mortise Lock with Regular/ Clutched Mortise Chassis

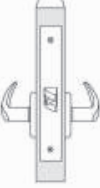
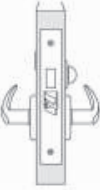
## Functions

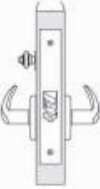
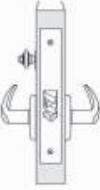
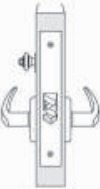

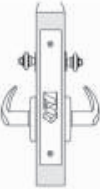



※In clutched mechanism, levers rotate up and down freely in the locked or unlocked position

Outside	Inside	Series/ Function	Type	ANSI No.	Function Description
		MSS-01 MSE-01	Passage or Closet	F01	Latch bolt operated by lever from either side at all times.
		MSS-02 MSE-02	Privacy or Bathroom	F02	Latch bolt operated by lever from either side. Dead bolt operated by turn from inside and emergency release from outside.
		MSS-04 MSE-04	Entry/ Office	F04	Latch bolt operated by lever from either side, except when outside lever is made inoperative by a push button rocker. When outside lever is locked, latch bolt is retracted by key from outside or by operating inside lever. ***Auxiliary dead latch.
		MSS-05 MSE-05	Classroom	F05	Latch bolt operated by lever from either side, except when outside lever is locked from outside by key. When outside lever is locked, latch bolt may be retracted by key, or by operating key and outside lever or by operating inside lever. ***Auxiliary dead latch.
		MSS-06 MSE-06 <small>**Clutch unavailable</small>	Holdback	F06	Latch bolt operated by lever either side, except when outside lever is locked from outside by key. Latch bolt can be locked in a retracted position by key. When outside lever is locked, latch bolt is retracted by key from outside or by operating inside lever unless latch bolt has been locked in a retracted position. ***Auxiliary dead bolt latch.
		MSS-07 MSE-07	Storeroom or Closet	F07	Latch bolt operated by key from outside or by rotating inside lever. Outside lever is always inoperative. ***Auxiliary dead latch.
		MSS-08 MSE-08	Front Door or Corridor Lock	F08	Latch bolt operated by lever from either side, except when outside lever is made inoperative by a push button rocker. Dead bolt is operated by turn inside. Key outside operates both bolts.
		MSS-09 MSE-09 <small>**Clutch unavailable</small>	Apartment / Exit or Public Toilet	F09	Latch bolt operated by lever from either side, except when outside lever is locked by key from inside. When outside lever is locked, latch bolt is retracted by key from outside or by operating inside lever. ***Auxiliary dead bolt latch.

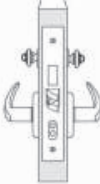
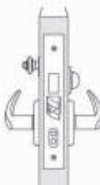

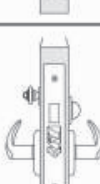
# MS Series Mortise Lock with **Regular/ Clutched** Mortise Chassis







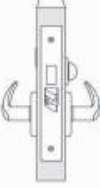

※In clutched mechanism, levers rotate up and down freely in the locked or unlocked position

Functions						
Outside	Inside	Series/ Function	Type	ANSI No.	Function Description	
		MSS-11 MSE-11 <small>**Clutch unavailable</small>	Dormitory or Exit Lock	F11	Latch bolt operated by lever from either side except when outside lever is made inoperative by a stop or mechanical means other than key. Dead bolt projected by key from either side. Dead bolt retracted by key from outside. Both bolts retracted by inside lever and outside remain locked.	
		MSS-12 MSE-12	Dormitory or Exit	F12	Latch bolt operated by lever from either side, except when outside lever is made inoperative by a stop or mechanical means other than key. Dead bolt projected by key from outside and by turn from inside. Deadbolt retracted by key from outside and by turn from inside. Operating inside lever retracts both bolts and outside remains locked.	
		MSS-13 MSE-13	Dormitory or Exit	F13	Latch bolt operated by lever from either side. Dead bolt projected by key from outside and thumb turn from inside. Operating inside lever retracts both bolts and unlocks outside.	
		MSS-14 MSE-14	Store Door	F14	Latch bolt operated by lever from either side. Dead bolt operated by key from either side.	
		MSS-15 MSE-15	Hotel or Guest	F15	Latch bolt operated by key from outside or by rotating inside lever. Outside lever is always inoperative. Dead bolt operated by thumb turn from inside and all keys except emergency and display key are shut out. Operating inside lever retracts both bolts. ***Auxiliary dead bolt latch.	
		MSS-16 MSE-16 <small>**Clutch unavailable</small>	Deadlock	F16	Dead bolt operated by key on either side.	
		MSS-17 MSE-17 <small>**Clutch unavailable</small>	Deadlock	F17	Dead bolt operated by key outside and turn piece inside.	
		MSS-18 MSE-18 <small>**Clutch unavailable</small>	Deadlock	F18	Dead bolt by key from outside only.	

# MS Series Mortise Lock with **Regular/Clutched** Mortise Chassis

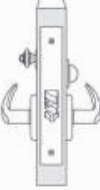
## Functions





※ In clutched mechanism, levers rotate up and down freely in the locked or unlocked position

Outside	Inside	Series/ Function	Type	ANSI No.	Function Description
		MSS-19 MSE-19	Privacy or Bathroom	F19	Latch bolt operated by lever from either side. Dead bolt operated by turn from inside and emergency release from outside. Operating inside lever retracts both bolts.
		MSS-20 MSE-20	Entrance/ Apartment/ Dormitory	F20	Latch bolt operated by lever from either side, except when outside lever is made inoperative by push button rocker. Dead bolt projected by key from outside and by thumb turn from inside. Key outside operates both bolts. Operating inside lever retracts both bolts and outside remains locked. Latch bolt is deadlocked when outside lever is made inoperative or when the dead bolt is projected. When dead bolt is retracted, lever is unlocked by stop or mechanical means other than key.
		MSS-21 MSE-21 <small>**Clutch unavailable</small>	Dormitory with Dead bolt	F21	Latch bolt operated by lever either side. Dead bolt operated by key outside or by turn from inside.
		MSS-22 MSE-22	Privacy	F22	Latch bolt operated by lever from either side, except when outside lever is locked by inside turn. Operating inside lever, closing door or operating outside emergency release unlocks outside lever.
		MSS-26 MSE-26 <small>**Clutch unavailable</small>	Institutional Privacy	F26	Latch bolt operated by lever from either side, except when outside lever is locked by turn inside. Latch bolt operated by key outside with override of turn inside when manually held in locked position. Operating inside lever or closing door unlocks outside lever. ***Auxiliary dead latch.
		MSS-29 MSE-29	Classroom Dead bolt	F29	Key from outside operates dead bolt. Turn from inside retracts but does not project dead bolt.
		MSS-30 MSE-30	Institutional	F30	Latch bolt operated by key either side. Both levers always inoperative. ***Auxiliary dead bolt latch.
		MSS-31 MSE-31 <small>**Clutch unavailable</small>	Exit or Communicating	F31	Latch bolt operated by lever from inside. Non removable blank lever or no lever outside. ***Auxiliary dead bolt latch.

# MS Series Mortise Lock with **Regular/Clutched** Mortise Chassis

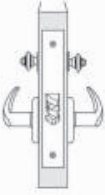
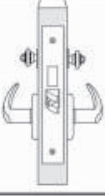
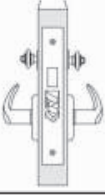
## Functions

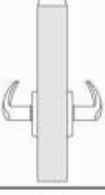
※In clutched mechanism, levers rotate up and down freely in the locked or unlocked position

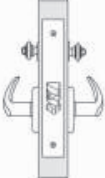
Outside	Inside	Series/ Function	Type	ANSI No.	Function Description
		MSS-32 MSE-32	Intruder Latch bolt	F32	Latch bolt operated by lever either side, except when outside lever is locked from inside or outside by key. When outside lever is locked, latch bolt is retracted by key from inside or outside or by operating inside lever. ***Auxiliary dead bolt latch
		MSS-33 MSE-33	Intruder Dead bolt	F33	Latch bolt operated by lever either side, except when outside lever is locked from inside or outside by key. Dead bolt operated by key either side. Inside lever retracts both bolts and unlocks outside lever.
		MSS-34 MSE-34	Intruder Dead bolt	F34	Latch bolt operated by lever either side, except when outside lever is locked from inside or outside by key. Dead bolt operated by key either side. Operating inside lever retracts both bolts and unlocks outside. *** Auxiliary dead latch or latch bolt dead locked when dead bolt is thrown.
		MSS-35 MSE-35	Storeroom with Dead bolt	F35	Latch bolt operated by lever from either side, except when outside lever is made inoperative by a stop or mechanical means other than key. Dead bolt operated by key from either side.
		MSS-41 MSE-41	Single Dummy		No Lock works, Lever one side only.
		MSS-42 MSE-42	Double Dummy		No Lock works, Lever on both sides.
		MSS-81 MSE-81 <small>**Clutch unavailable</small>	Hotel Privacy		Latch bolt retracted by key from outside and thumb turn from inside. ***Auxiliary dead bolt latch.
		MSS-82 MSE-82 <small>**Clutch unavailable</small>	Storeroom with Double Cylinder		Latch bolt operated by key from either side. both levers always rigid. ***Auxiliary dead bolt latch.

[www.townsteel.com](http://www.townsteel.com)



17901 Railroad Street, City of Industry, CA 91748  
Toll Free: (877) 858-0888 Tel: (626) 965-8917 Fax: (626) 965-8919  
[sales@townsteel.com](mailto:sales@townsteel.com)